



INSTRUCTION SHEET FOR TOOL #5830

MILWAUKEE EIGHT MAIN SEAL REMOVER Fits 2017-Present Milwaukee 8 Engines

CAUTION: Wear safety glasses. Excessive force may damage the parts!

1. Align one wrist of puller arm with the crank shaft, insert puller arm knuckle into seal and rotate arm toward crank shaft. The knuckle of puller arm should engage rear of seal. End of puller arm should contact bearing spacer. The knuckle of puller arm is the smaller end flange. **Fig. 1 & Fig. 2**
2. Repeat process with other arm, maintaining 180 degree alignment. **Fig. 3**
3. Place Shaft Plug # 995-3 onto the end of the crank shaft, inserting the smaller diameter fully. **Fig. 4**
4. Slide spacer # 5830-2 onto crank shaft, align the flats with the puller arms. Fully seat the spacer into seal. **Fig. 5**
5. Slide key plate # 5830-3 over ends of arms, aligning arms into milled slots in keyway. **Fig. 6**
6. Screw 5/8-11 nut # 2000 onto the end of the Puller # 1024, with the Puller # 1024 stopping approximately $\frac{3}{4}$ of the way through the nut. Place a few drops of oil or grease onto the face of the Puller # 1024. **Fig. 7**
7. Slide the Nut # 2000 between the Puller Arms # 5830-1, aligning flats of nut with inner flats on arms. **Fig. 8**
8. Key plate # 5830-3 will not slide over spacer # 5830-2. The key plate may be slid towards the nut # 2000 to verify the alignment of the puller # 1024 and the shaft plug # 995-3. The key plate should be slid back into contact with the spacer to ensure that the arms are fully supported on the nut # 2000 when the seal is being removed.
9. Rotate Screw # 1024 by hand slowly until the center point is centered on the Shaft Plug # 995-3. Hand tighten until the puller presses the spacer against the crank shaft.
10. Using a 3/4" wrench or socket, turn the puller clockwise. **DO NOT USE IMPACT TOOLS** or tool damage will occur.

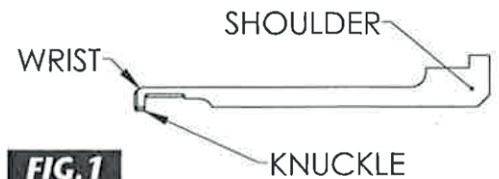

FIG. 1

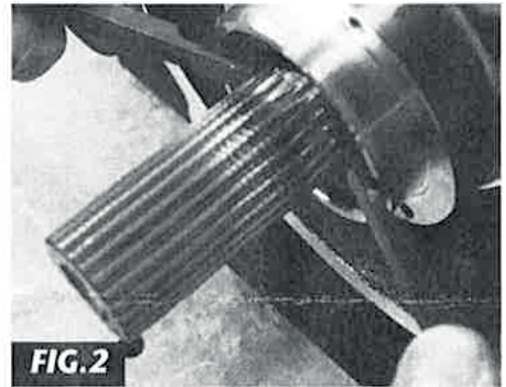

FIG. 2

**NOTE: PLEASE READ ALL INSTRUCTIONS COMPLETELY BEFORE PERFORMING ANY WORK!
IF YOU DO NOT KNOW WHAT YOU ARE DOING, DO NOT DO IT!**

No information in this instruction sheet pertaining to motorcycle repair is represented as foolproof or even altogether safe. Even something safe, done incorrectly or incompletely, can and will backfire. You and only you are responsible for the safety of your repair work and for you understanding the application and use of repair equipment, components, methods and concepts.

Each and every step this tool is designed to do must be carefully and systematically performed safely by you. All information listed in this instruction sheet has been tested, re-tested and used daily in JIMS® Research and Development Department.

ALWAYS WEAR SAFETY GLASSES OR OTHER FACE AND EYE PROTECTION SUCH AS FULL FACE SHIELD. JIMS® IS NOT RESPONSIBLE FOR DAMAGE, INJURY, OR YOUR WORK. JIMS® IS NOT RESPONSIBLE FOR THE QUALITY AND SAFETY OF YOUR WORK.

Performance Parts For Harley-Davidson Motorcycles



A Division of Thiessen Products, Inc.

INSTRUCTION SHEET FOR TOOL #5830

- 11. Turn puller until seal is removed.
- 12. Disassemble puller, wipe down, store appropriately.

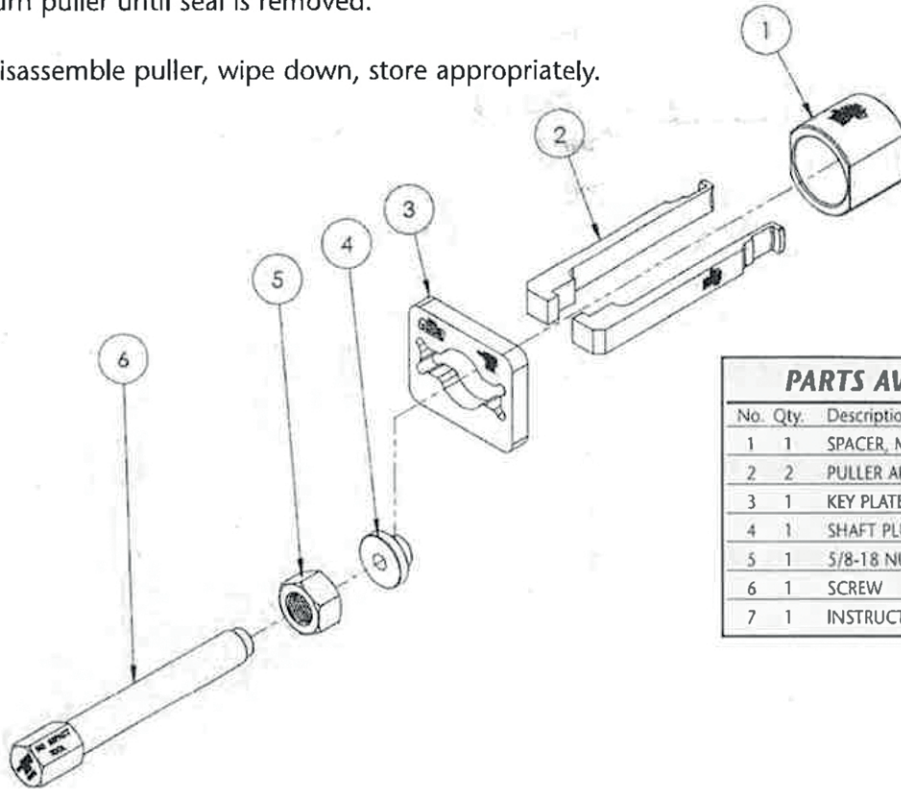

PARTS AVAILABLE SEPARATELY			
No.	Qty.	Description	Part No.
1	1	SPACER, MAIN SEAL PULLER, M8	5830-2
2	2	PULLER ARM	5830-1
3	1	KEY PLATE	5830-3
4	1	SHAFT PLUG	995-3
5	1	5/8-18 NUT GRADE 5	2000
6	1	SCREW	1024
7	1	INSTRUCTION SHEET	5830-IS

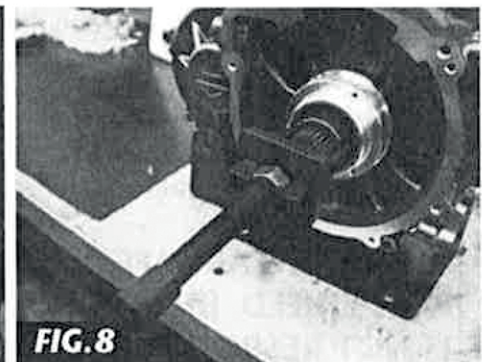
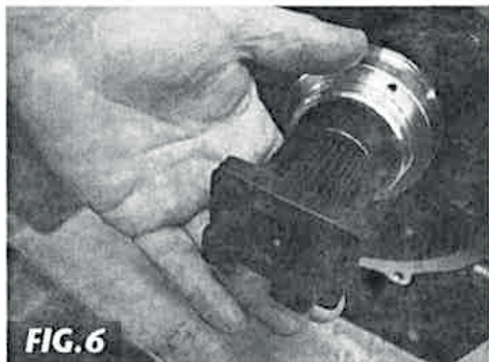
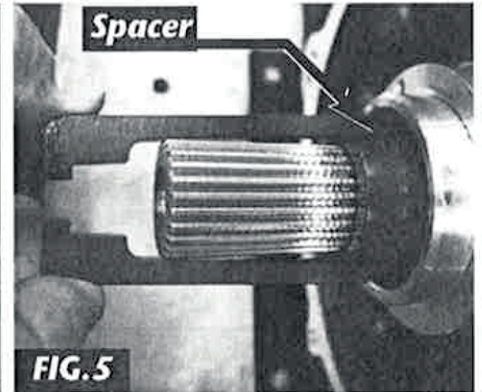
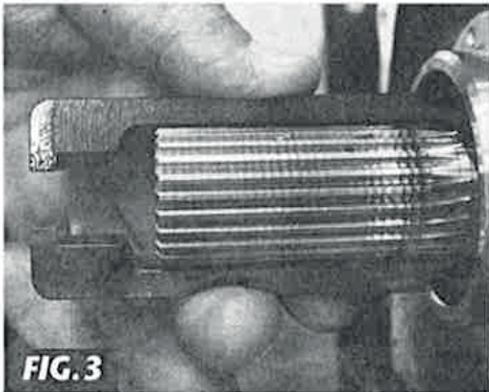

Performance Parts For Harley-Davidson Motorcycles